

## SPICE thermal model

BUK7Y28-75B

Symbol	Parameter	Conditions	Min	Typ	Max	Unit
$R_{th(j-mb)}$	thermal resistance from junction to mounting base		-	-	1.8	K/W

$C_{th1}$	2.589E-02 F
$C_{th2}$	4.042E-03 F
$C_{th3}$	9.598E-04 F
$C_{th4}$	2.279E-04 F
$C_{th5}$	5.413E-05 F
$C_{th6}$	1.285E-05 F
$C_{th7}$	3.053E-06 F
$C_{th8}$	7.249E-07 F
$R_{th1}$	1.159E+00 $\Omega$
$R_{th2}$	4.498E-01 $\Omega$
$R_{th3}$	1.148E-01 $\Omega$
$R_{th4}$	2.929E-02 $\Omega$
$R_{th5}$	7.473E-03 $\Omega$
$R_{th6}$	1.907E-03 $\Omega$
$R_{th7}$	4.865E-04 $\Omega$
$R_{th8}$	1.241E-04 $\Omega$

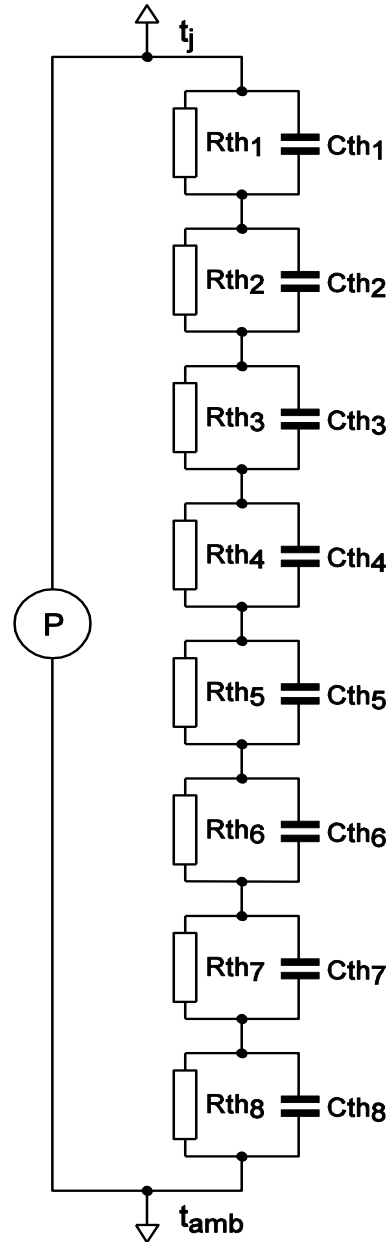

001aal768

Part: BUK7Y28-75B  
 Version: 1  
 Date: 23-3-2010  
 Rth: 1.8